

NOTE. ROD-EYE ORIENTATION NOT GUARANTEED

ELECTRICAL OPTIONS/ SPECIFICATIONS
 OUTPUT SUPPLY (NOM)
 'A' 0.5 - 4.5V RATIOMETRIC 5V
 SUPPLY CURRENT 12mA TYP. 20mA MAX.

CONNECTIONS:	CABLE	
	3-CORE	5-CORE
+Ve	RED	RED
+SENSE (5-WIRE ONLY)	-	ORANGE
0V	BLACK	BLACK
-SENSE (5-WIRE ONLY)	-	GRAY
OUTPUT	WHITE	BLUE
BODY	SCREEN	SCREEN

CABLE; 0.2mm², O/A SCREEN, PUR JACKET, SUPPLIED WITH 50cm OR REQUIRED LENGTH IN cm (15000cm MAX).
 STANDARD 3-CORE: BLACK Ø4mm JACKET e.g. L50
 OPTIONAL 5-CORE: BLUE Ø4.6mm JACKET e.g. LQ50

RANGE OF DISPLACEMENT FROM 0-5mm TO 0-800mm e.g. 76.
 BODY MATERIAL:- STAINLESS STEEL 316.

FURTHER OPTIONS:
 BODY CLAMP CODE 'P'
 TWO BODY CLAMPS CODE 'P2'
 CLAMP CONSISTS OF 2 PARTS AND
 REQUIRES 2 OFF M6x55 (MIN.) CAPHEAD SCREWS.

SPRUNG PUSH-ROD, ≤300mm:
 EXTENDED POSITION CODE 'R'. RETRACTED CODE 'S'
 PUSH-ROD FREE CODE 'V' - NOT AVAILABLE WITH CODES 'R' OR 'S'

A

B

C

D

E

F

A

B

C

D

E

F

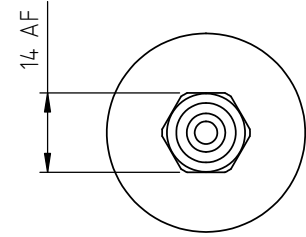

IP68 CABLE GLAND
 (CODE 'Lxx'/'LQxx')

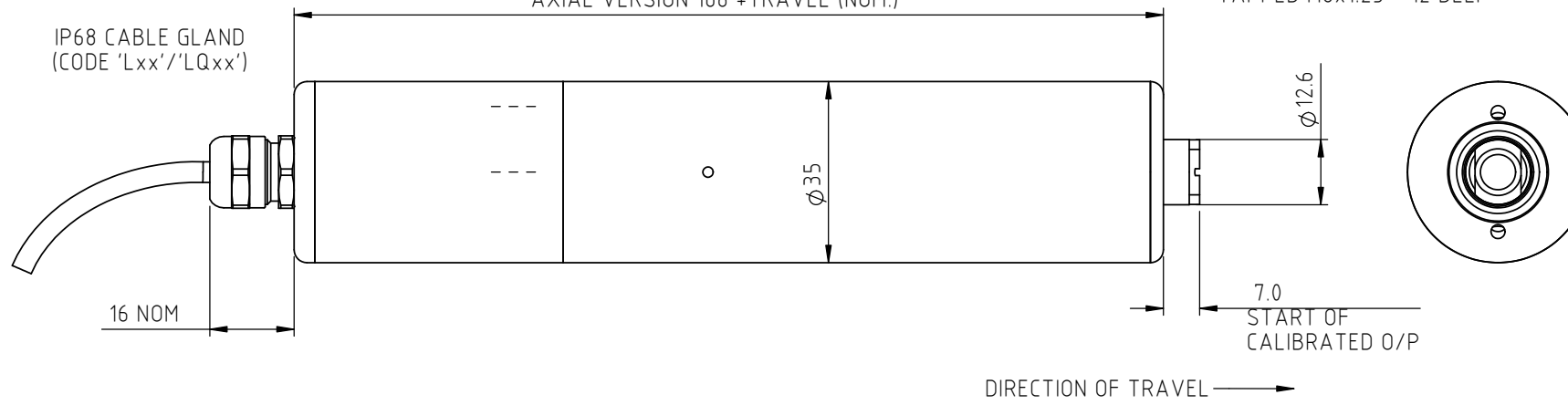

STANDARD TARGET
 TAPPED M8x1.25 - 12 DEEP

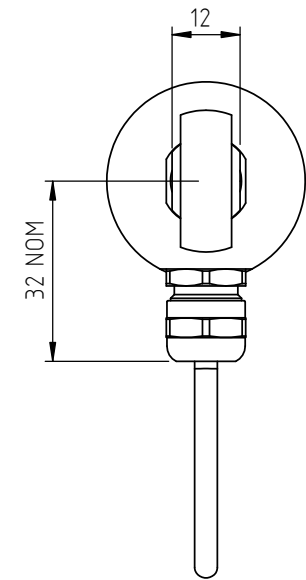
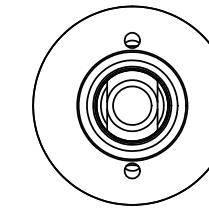

M8 ROD EYE
 (CODE 'N')

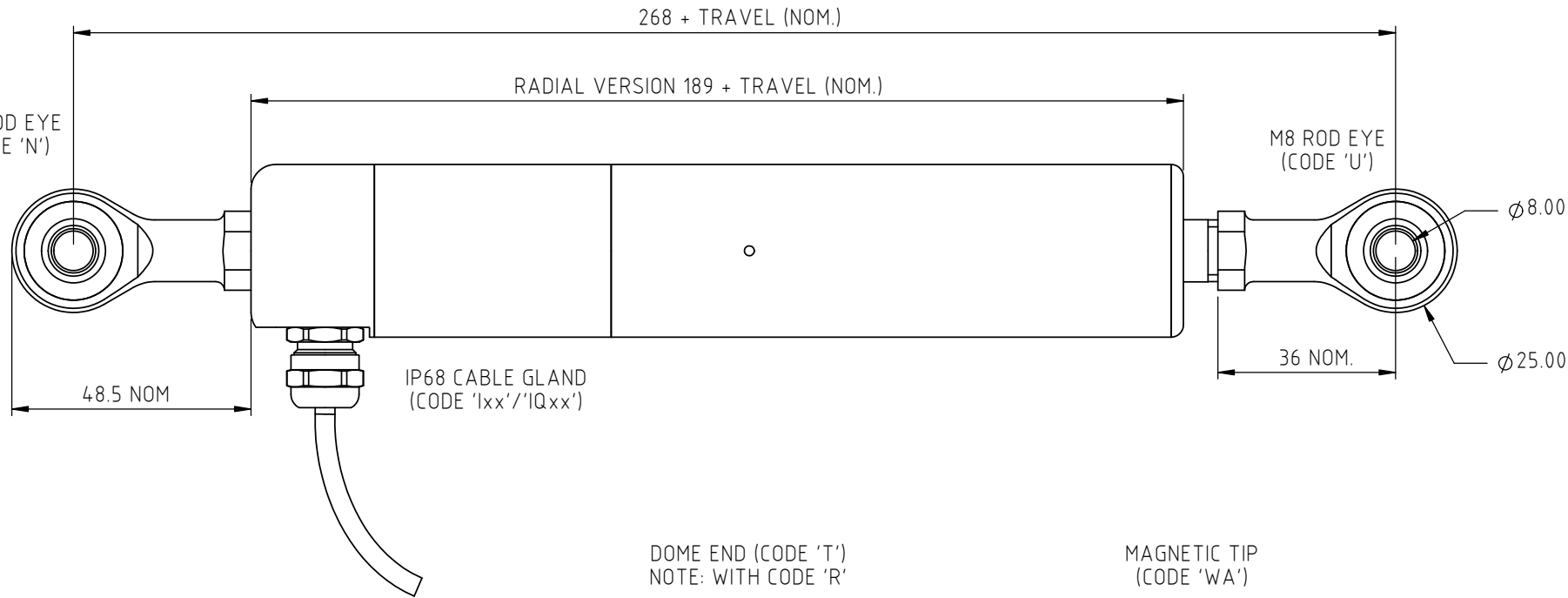

M8 ROD EYE
 (CODE 'U')

IP68 CABLE GLAND
 (CODE 'Ixx'/'IQxx')

DOME END (CODE 'T')
 NOTE: WITH CODE 'R'

MAGNETIC TIP
 (CODE 'WA')

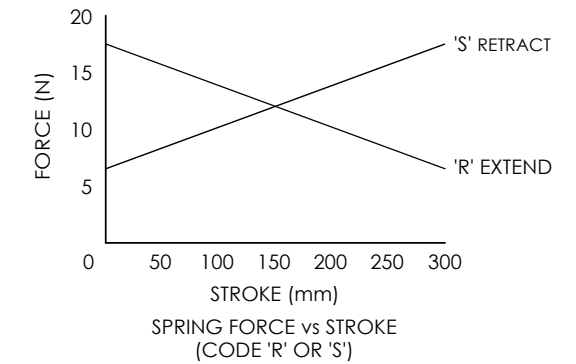
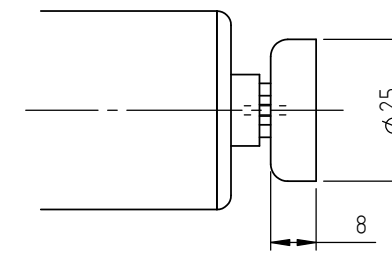
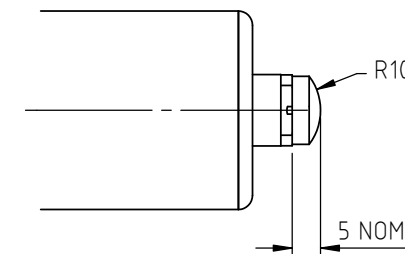

NOTE:- READ INSTALLATION SHEET X115-19
 FOR FULL INSTRUCTIONS FOR USE.

ATEX / IECEx / UKEX APPROVED TO

Ex ia IIC T4 Ga (Ta= -40° to +80°C)
Ui 11.4V, Ii 0.2A, Pi 0.51W

APPROVED FOR USE IN CONJUNCTION
 WITH A GALVANICALLY ISOLATED BARRIER.

NOTE: APPROVAL ONLY APPLIES AT NORMAL
 ATMOSPHERIC PRESSURE!

MAXIMUM WORKING DEPTH: 100m (328 ft).
 WHERE THE FREE END OF THE CABLE IS TO BE TERMINATED IN A SUBMERGED
 POSITION, ADEQUATE SEALING MUST BE PROVIDED TO PROTECT CONNECTIONS.

DRAWINGS NOT TO BE CHANGED WITHOUT REFERENCE TO THE CHANGE PROCEDURE.
 CHANGES TO PARTS USED IN INTRINSICALLY SAFE PRODUCT MUST BE APPROVED BY THE AUTHORISED PERSON.
 THIS IS AN UNCONTROLLED PRINT AND WILL NOT BE UPDATED.

REV	CHANGE HISTORY	DR'WN	DATE	CHK'D
Q	RAN1311 - MAGNETIC TIP OPTION 'WA' ADDED	ASC	02/06/2023	ASC

THE PUSH-ROD RETRACTS 4mm NOM. BACK FROM THE START OF CALIBRATED TRAVEL.
 THE PUSH-ROD EXTENDS 8mm NOM. BEYOND THE END OF CALIBRATED TRAVEL.
 SPRUNG OPTIONS:- CODE 'R': 1mm, CODE 'S': 2mm.
 CODE 'V': PUSH-ROD NOT RETAINED.



APPROVED BY RDM	REV Q		X ±0.4 X.X ±0.2 X.XX ±0.1 DIMs mm
DESCRIPTION X115 INTRINSICALLY SAFE RUGGED SUBMERSIBLE STAND ALONE LINEAR POSITION SENSOR			
SCALE 3:4	DRAWING NUMBER X115-11		
A3	SHEET 1 OF 1		



X115 RUGGED SUBMERSIBLE STAND-ALONE LINEAR POSITION SENSOR INTRINSICALLY SAFE FOR HAZARDOUS GAS/VAPOUR ATMOSPHERES

- **Intrinsically safe for Gas to:
Ex II 1G**
- **Non-contacting inductive technology
to eliminate wear**
- **Travel set to customer's requirement**
- **Compact and self-contained**
- **High durability and reliability**
- **High accuracy and stability**
- **Sealing to IP68 10bar/IP69K**



As a leading designer and manufacturer of linear, rotary, tilt and intrinsically safe position sensors, Positek® has the expertise to supply a sensor to suit a wide variety of applications. Our intrinsically safe X115 incorporates electronics system EX07 which is ATEX / IECEx / UKEX approved for use in potentially explosive **gas/ vapour** atmospheres. The X115 is a heavy-duty version of the X114 sensor with a stronger 12.6mm push rod, recommended for applications where vibration is an issue or there is a need for longer travel sensors which are to be mounted horizontally between rod eyes. It remains an affordable, durable, high-accuracy position sensor designed for applications where the sensor would be completely submerged during normal operation. The unit is highly compact and space-efficient, being responsive along almost its entire length. Like all Positek® sensors, the X115 provides a linear output proportional to travel. Each sensor is supplied with the output calibrated to the travel required by the customer, from 5 to 800mm and with full EMC protection built in. The sensor is very robust, the body and push rod being made of 316 stainless steel for long service life and environmental resistance. Overall performance, repeatability and stability are outstanding over a wide temperature range. The sensor is easy to install with mounting options including stainless steel M8 rod eye bearings and body clamps. The push rod can be supplied free or captive with female M8 thread, an M8 rod eye, dome end or magnetic tip. M12 and 1/2" rod eye option available. Captive push rods can be sprung loaded, in either direction, on sensors up to 300mm of travel. The X115 also offers a selection of mechanical and electrical options, environmental sealing is to IP68 10bar/IP69K.

SPECIFICATION

Dimensions

Body diameter	35 mm
Body length (Axial version)	calibrated travel + 168 mm
Body length (Radial version)	calibrated travel + 189 mm
Push rod extension	calibrated travel + 7 mm, OD 12.6 mm

For full mechanical details see drawing X115-11

Independent Linearity

$\leq \pm 0.25\%$ FSO @ 20°C - up to 450 mm
$\leq \pm 0.5\%$ FSO @ 20°C - over 450 mm
$< \pm 0.01\%/^{\circ}\text{C}$ Gain &
$< \pm 0.01\%$ FS/ $^{\circ}\text{C}$ Offset
> 10 kHz (-3dB)

Temperature Coefficients

Frequency Response

Resolution

Noise

Intrinsic Safety

Approval only applies to the specified ambient temperature range and atmospheric conditions in the range 0.80 to 1.10 Bar, oxygen $\leq 21\%$

Sensor Input Parameters

(without cable)	Ui: 11.4V, Ii: 0.20A, Pi: 0.51W.
(with cable)	Ci: 1.16 μF , Li: 50 μH
	Ci: 1.36 μF , Li: 860 μH with 1km max. cable

Environmental Temperature Limits (Non Icing)

Operating	-40°C to +80°C
Storage	-40°C to +125°C

Sealing

EMC Performance

Vibration

Shock

MTBF

Drawing List

X115-11	Sensor Outline
3D models, step or .igs format, available on request.	

Do you need a position sensor made to order to suit a particular installation requirement or specification? We'll be happy to modify any of our designs to suit your needs - please contact us with your requirements.

For further information please contact:

www.positek.com sales@positek.com

Tel: +44(0)1242 820027 fax: +44(0)1242 820615

Positek, Andoversford Industrial Estate, Cheltenham GL54 4LB. U.K.





X115 RUGGED SUBMERSIBLE STAND-ALONE LINEAR POSITION SENSOR INTRINSICALLY SAFE FOR HAZARDOUS GAS/VAPOUR ATMOSPHERES

Intrinsically safe equipment is defined as "equipment which is incapable of releasing sufficient electrical or thermal energy under normal or abnormal conditions to cause ignition of a specific hazardous atmosphere mixture in its most easily ignited concentration."
ATEX / IECEx / UKEX approved to;

Ex II 1G
Ex ia IIC T4 Ga (Ta= -40°C to 80°C)

Designates the sensor as belonging to; Group II: suitable for all areas **except mining**, Category 1 G: can be used in areas with continuous, long or frequent periods of exposure to hazardous gas / vapour (Zones 2 to 0).

Gas / Vapour:

Protection class ia, denotes intrinsically safe for all zones

Apparatus group IIC: suitable for IIA, IIB and IIC explosive gas / vapour.

Temperature class T4: maximum sensor surface temperature under fault conditions 135°C.

Ambient temperature range extended to -40°C to +80°C.

It is imperative Positek® intrinsically safe sensors be used in conjunction with a galvanic barrier to meet the requirements of the product certification. The Positek X005 Galvanic Isolation Amplifier is purpose made for Positek IS sensors making it the perfect choice. Refer to the X005 datasheet for product specification and output configuration options.

For cable lengths exceeding 10 metres a five wire connection is recommended to eliminate errors introduced by cable resistance and associated temperature coefficients.

ATEX / IECEx / UKEX approved sensors suitable for dust (E series) and mining (M series) applications, are also available from Positek.

X115	a	b	c	d	e	f	g	h	j
	Displacement	A	Connections	Option	Option	Option	Option	Option	Z000

a Displacement	Value	f Sprung Push Rod	Code
Factory set to any length from 0-5 mm to 0-800 mm (e.g. 0-254 mm)	254	Not sprung default	blank
b Output		Spring extend	R
Supply V_{dc} (tolerance)	Output	Spring retract	S
+5V (4.5 - 5.5V)	0.5 - 4.5V (ratiometric with supply)	300 mm maximum displacement and captive push rod only.	
Supply Current 10mA typical, 12mA max.	A	g Push Rod Fittings	Code
c Connections	Code	Female thread M8x1.25x12 deep default	blank
Cable gland radial IP68 10bar/IP69K Pg7, 3-core cable	Ixx	Dome end with spring extend option 'R'	T
Cable gland radial IP68 10bar/IP69K Pg7, 5-core cable	IQxx	M8 Rod-eye Bearing	U
Cable gland axial IP68 10bar/IP69K Pg7, 3-core cable	Lxx	Magnetic Tip	WA
Cable gland axial IP68 10bar/IP69K Pg7, 5-core cable	LQxx	h Push Rod	Code
Specify required cable length 'xx' in cm. e.g. L2000 specifies axial cable gland with 20 m of cable, 50 cm supplied as standard. Note! maximum length supplied 15000cm.		Captive push rod retained default	blank
d Body Fittings	Code	Non-captive push rod can depart body	V
None default	blank	j Z-code	Code
M8 Rod-eye bearing radial version only	N	Calibration to suit X005 required	Z000
e Body Clamps	Code	Tighter Independent Linearity; $\leq \pm xx\%$ FSO @20°C	Z650
Body Clamps 1 pair	P	$\leq \pm 0.1\%$ 0 - 10 mm min. to 0 - 450 mm	
Body Clamps 2 pairs	P2	$\leq \pm 0.25\%$ 0 - 451 mm to 0 - 600 mm	
		$\leq \pm 0.5\%$ 0 - 601 mm to 0- 800 mm max.	
		1/2" Rod eyes with options 'N' and/or 'U'	Z825
		M12 Rod eyes with options 'N' and/or 'U'	Z826

Output Characteristic - Standard

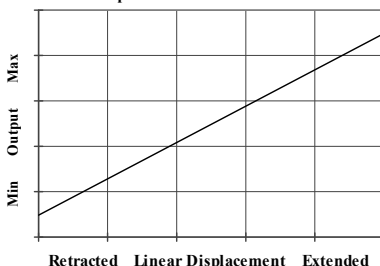

For further information please contact:

www.positek.com sales@positek.com

Tel: +44(0)1242 820027 fax: +44(0)1242 820615

Positek, Andoversford Industrial Estate, Cheltenham GL54 4LB. U.K.

X115-17q

2 of 3



Three or Five-Wire Mode Connection FOR INTRINSICALLY SAFE SENSORS IN HAZARDOUS ATMOSPHERES

The aim of this document is to help readers who do not understand what is meant by three or five wire modes of connection between the galvanic isolation amplifier and sensor, and the factors behind them. It is by no means an in-depth technical analysis of the subject.

Whether opting for a pre-wired Positek® Intrinsically Safe sensor or one with a connector, choosing the right mode of connection and cable to suit the application requires careful consideration.

Interconnecting cables are not perfect conductors and offer resistance to current flow, the magnitude of resistance[†] depends on conductors resistivity, which changes with temperature, cross sectional area[‡] and length. If the voltage were to be measured at both ends of a length of wire it would be found they are different, this is known as volts drop. Volts drop changes with current flow and can be calculated using Ohm's law, it should be noted that volts drop occurs in both positive and negative conductors. The effects of volts drop can be reduced by increasing the conductors cross sectional area, this does not however eliminate the effects due to temperature variation. There are instances where large cross-section cables are not practical; for example most standard industrial connectors of the type used for sensors have a maximum conductor capacity of 0.75mm², copper prices and ease of installation are other considerations.

This is important because the effects of volts drop can significantly alter the perceived accuracy of the sensor which is ratiometric i.e. the output signal is directly affected by the voltage across the sensor. Changes in temperature will also be seen as gain variation in the sensor output.

Three wire mode connections are common and are suitable in most cases with short or moderate cable runs. Applications that do not require a high degree of accuracy but have cable runs, say in excess of 10m, volts drop can be reduced by introducing a terminal box close to the sensor and using a larger cross-section cable for a majority of the cable run. Sensors supplied with three core cable are calibrated with the cable fitted which largely eliminates errors due to conductor resistance at room temperature however, as mentioned above, small gain errors due to temperature fluctuations should be expected.

Five wire mode connections have significant benefits as losses in the positive and negative conductors are compensated for by the galvanic isolation amplifier which can 'sense' the voltage across the sensor and dynamically adjust the output voltage so that the voltage across the sensor is correct. The effects of cable resistance and associated temperature coefficients are eliminated allowing for smaller conductors than a three wire connection for the same cable run. The amplifier can compensate for up to 15Ω per conductor with a current flow of 15mA, which is more than adequate for 150m of 0.25 mm² cable, longer lengths will require larger conductors.

For this reason Positek® recommends five wire connections for cable lengths exceeding 10 metres in 0.25 mm² cable to preserve the full accuracy of the sensor.

See illustrations below for examples of connecting a sensor to the galvanic isolation amplifier.

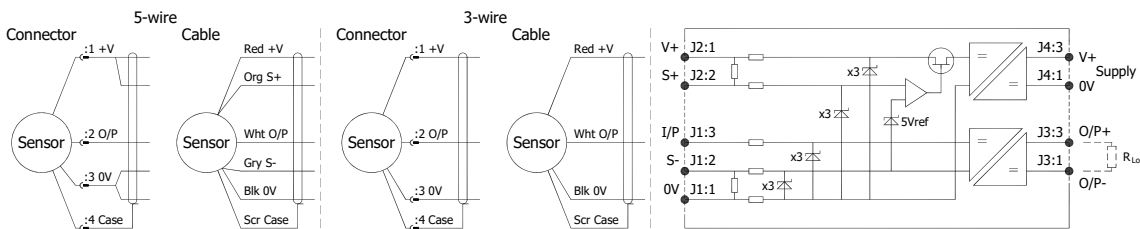

Cable Length (metres)	Up to 150	150 - 300	300 - 450	450 - 600	600 - 900	900 - 1000
Cross Section (mm ²)	0.25	0.5	0.75	1.0	1.5	2.0

The table above shows recommended conductor sizes with respect to cable length for both three and five wire connections, based on copper conductors. Three wire connections will introduce a gain reduction of 5% and a ±1% temperature dependence of gain over the range -40°C to +80°C for the cable temperature. (i.e. about -150 ppm/°C for the maximum lengths shown and less pro rata for shorter lengths.)

It should be noted that the maximum cable length, as specified in the sensor certification, takes **precedence** and **must not** be exceeded.

Positek® sensors are supplied with three core 0.25 mm² cable as standard, however five core 0.25 mm² cable can be supplied on request. The galvanic isolation amplifier is available as;

- G005-*** for 'G' and 'H' prefix sensors
- X005-*** for 'E', 'M' and 'X' prefix sensors

[†] $R = \rho L/A$ ρ is the resistivity of the conductor (Ωm) L is the length of conductor (m) A is the conductor cross-sectional area (m²).

[‡] It is presumed that direct current flow is uniform across the cross-section of the wire, the galvanic isolation amplifier and sensor are a dc system.



For further information please contact:

www.positek.com sales@positek.com

Tel: +44(0)1242 820027 fax: +44(0)1242 820615

Positek, Andoversford Industrial Estate, Cheltenham GL54 4LB. U.K.



Installation Information

X115 RUGGED SUBMERSIBLE STAND-ALONE LINEAR POSITION SENSOR

INTRINSICALLY SAFE FOR HAZARDOUS GAS/VAPOUR ATMOSPHERES

For certificate number and safety parameters information for product marked EX04, see next page.

ATEX / IECEx / UKEX Qualified to Intrinsic Safety Standard Certificate numbers SIRA 13ATEX2371X IECEX SIR 13.0154X CSAE 21UKEX2537X		Ex II 1G Ex ia IIC T4 Ga (Ta = -40°C to +80°C)	
Electronics Version	Output Description:	Supply Voltage: V _s (tolerance)	Load resistance:
EX07	0.5 - 4.5V (ratiometric with supply) [Output code 'A']	+5V (4.5 - 5.5V)	5kΩ min

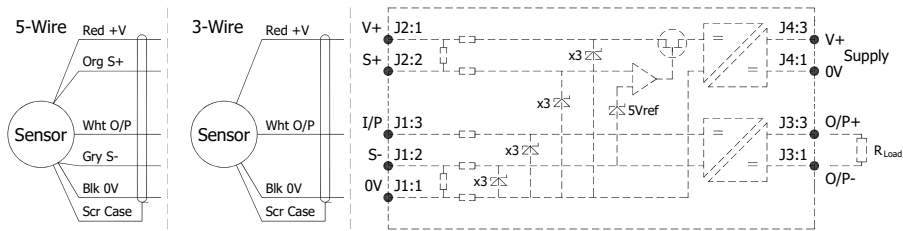

Putting Into Service: The sensor must be used with a galvanic isolation barrier designed to supply the sensor with a nominal 5V and to transmit the sensor output to a safe area. The barrier parameters must not exceed:-

U_i = 11.4V **I_i = 0.20A** **P_i = 0.51W**
C_i = 1.36μF* **L_i = 860μH*** (with maximum cable length)
C_i = 1.16μF **L_i = 50μH** (without cable)

*Figures for 1km cable where: C_i = 200pF/m & L_i = 810nH/m

The sensor is certified to be used with up to **1000m** of cable, cable characteristics must not exceed:-

Capacitance: ≤ 200 pF/m or max. total of: 200 nF
 Inductance: ≤ 810 nH/m or max. total of: 810 μH

Approval only applies to specified ambient temperature range and atmospheric conditions in the range: 0.80 to 1.10 Bar, oxygen ≤ 21%.

The performance of the sensor may be affected by voltage drops associated with long cable lengths; For cable lengths exceeding 10 metres a five wire connection is recommended to eliminate errors introduced by cable resistance and associated temperature coefficients.

N.b. Where the free end of the cable is to be terminated in a submerged position, adequate sealing must be provided to protect connections.

Special Condition for Safe Use:

The apparatus does not meet the 500 V r.m.s dielectric strength test between circuit and frame, in accordance with clause 6.3.13 of IEC 60079-11:2011. This must be taken into consideration on installation.

Under certain extreme circumstances, the non-metallic and isolated metal parts incorporated in the enclosure of this equipment may generate an ignition-capable level of electrostatic charge. Therefore the equipment shall not be installed in a location where the external conditions are conducive to the build-up of electrostatic charge on such surfaces. This is particularly important if the equipment is installed in a zone 0 location. In addition, the equipment shall only be cleaned with a damp cloth.

Use: The sensor is designed to measure linear displacement and provide an analogue output signal.

Assembly and Dismantling: The unit is not to be serviced or dismantled and re-assembled by the user.

Maintenance: No maintenance is required.

Mechanical Mounting: Depending on options; body can be mounted by rod eye bearing or by clamping the sensor body - body clamps are available, if not already ordered. Target by M8x1.25 female thread, rod eye bearing or magnetic tip. It is assumed that the sensor and target mounting points share a common earth.

Output Characteristic: Target is extended 7 mm from end of body at start of normal travel. The output increases as the target extends from the sensor body, the calibrated stroke is between 5 mm and 800 mm.

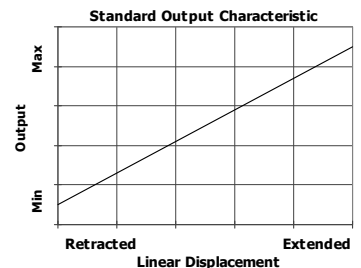

Incorrect Connection Protection levels: Not protected – the sensor is **not** protected against either reverse polarity or over-voltage. The risk of damage should be minimal where the supply current is limited to less than 50mA.



For further information please contact:
www.positek.com sales@positek.com
 Tel: +44(0)1242 820027 fax: +44(0)1242 820615
 Positek, Andoversford Industrial Estate, Cheltenham GL54 4LB. U.K.



Installation Information

X115 RUGGED SUBMERSIBLE STAND-ALONE LINEAR POSITION SENSOR

INTRINSICALLY SAFE FOR HAZARDOUS GAS/VAPOUR ATMOSPHERES

For certificate number and safety parameters information for product marked EX07, see previous page.

ATEX Qualified to Intrinsic Safety Standard Certificate numbers SIRA 00ATEX2076X		Ex II 1G EEx ia IIC T4 (Ta = -40°C to +80°C)	
Electronics Version	Output Description:	Supply Voltage: <small>V_s (tolerance)</small>	Load resistance:
EX04	0.5 - 4.5V (ratiometric with supply) [Output code 'A']	+5V (4.5 - 5.5V)	5kΩ min

The barrier parameters must not exceed:-

U_i = 11.4V **I_i = 0.20A** **P_i = 0.51W**
C_i = 1.36μF* **L_i = 710μH*** ('Ixx' or 'Lxx' options) *Figures for 1km cable
C_i = 1.16μF **L_i = 50μH** (without cable)

The sensor is certified to be used with up to **1000m** of cable, cable characteristics must not exceed:-

Capacitance: ≤ 200 pF/m for max. total of: 200 nF
Inductance: ≤ 660 nH/m for max. total of: 660 μH

With the exception of the certificate number and safety parameters above, all other notes regarding Putting Into Service, Use, Assembly and Dismantling etc. on previous page apply to sensors marked EX04 or EX07.



For further information please contact:
www.positek.com sales@positek.com
Tel: +44(0)1242 820027 fax: +44(0)1242 820615
Positek, Andoversford Industrial Estate, Cheltenham GL54 4LB. U.K.